

Brackets for gas springs and dampers Winkelbleche für Gasfedern und Dämpfer

Part No. / Bestell-Nr. **8262WE**
 $F_{max}^* = 1000 \text{ N}$

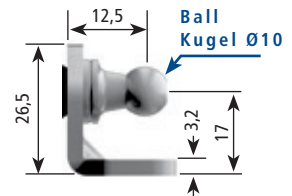

Part No. / Bestell-Nr. **8267WG**
 $F_{max}^* = 700 \text{ N}$

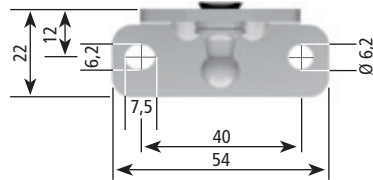
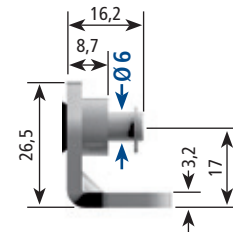
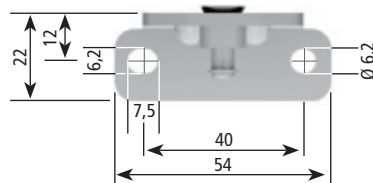

Part No. / Bestell-Nr. **8261WJ**
 $F_{max}^* = 1000 \text{ N}$

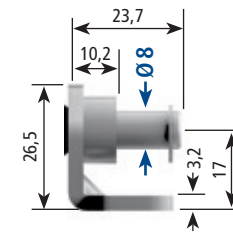
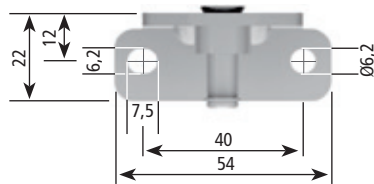

Part No. / Bestell-Nr. **8268WB**
 $F_{max}^* = 700 \text{ N}$

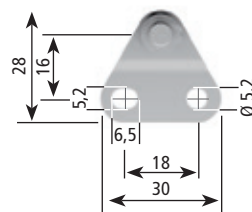

F_{max}^* = Maximum allowable force at 20°C in compressed position. Material: steel, zinc-plated.
 F_{max}^* = Maximale zulässige Belastung bei 20°C in eingeschobener Position. Material: Stahl, verzinkt.

Part No. / Bestell-Nr. **8264WV**

$F_{max}^* = 1000 \text{ N}$

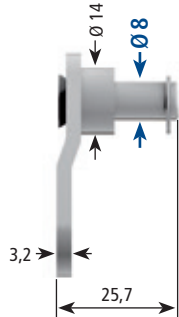
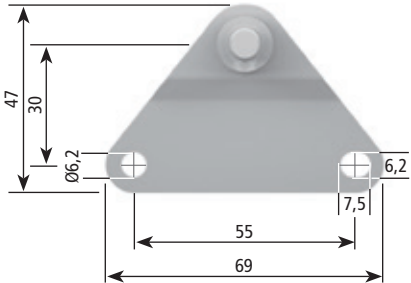

Part No. / Bestell-Nr. **8265WQ**

$F_{max}^* = 1000 \text{ N}$

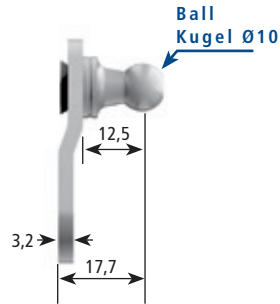
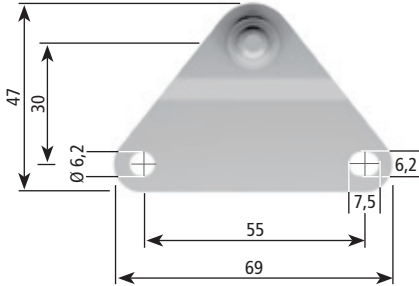

Part No. / Bestell-Nr. **023189**

$F_{max}^* = 700 \text{ N}$

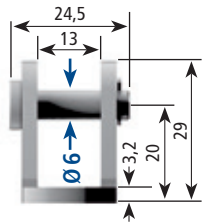
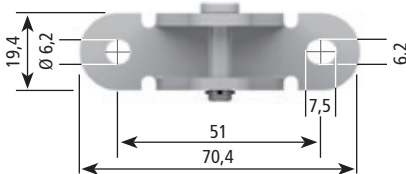
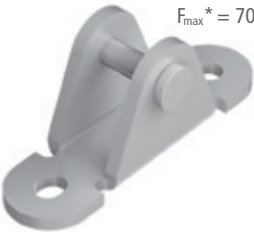

Part No. / Bestell-Nr. **023083**

$F_{max}^* = 1600 \text{ N}$

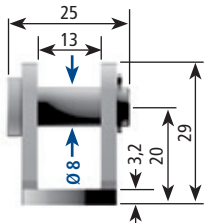
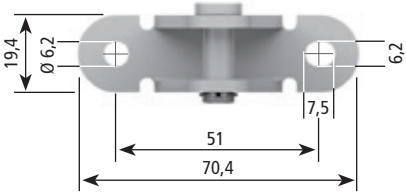
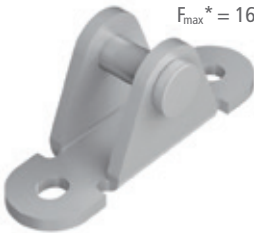

Brackets for gas springs and dampers Winkelbleche für Gasfedern und Dämpfer

Part No. / Bestell-Nr. **9222SJ**
F_{max}* = 500 N

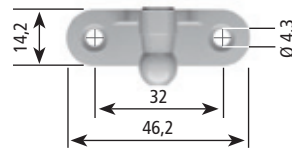

Part No. / Bestell-Nr. **7592TM**
F_{max}* = 350 N

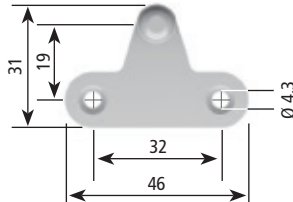

Part No. / Bestell-Nr. **6284UG**
F_{max}* = 500 N

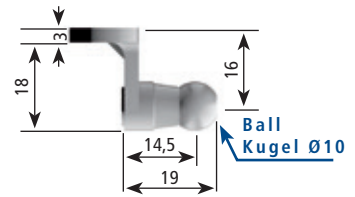
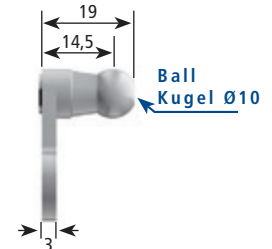
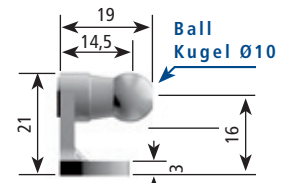
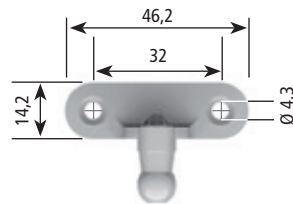

Ball stud / Kugelzapfen

4565BD
Clear passivated / Klar passiviert

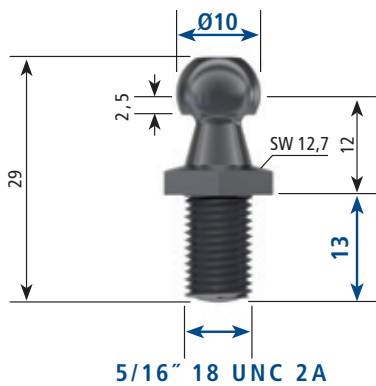

4486MD
Black passivated / Schwarz passiviert

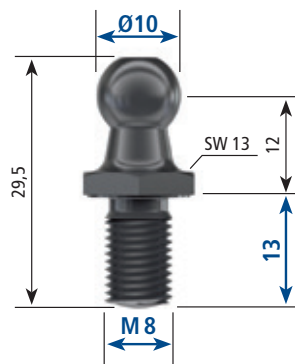

177583
Black passivated / Schwarz passiviert



8442LT
Black passivated / Schwarz passiviert



072796
Black passivated / Schwarz passiviert



2054QF
Clear passivated / Klar passiviert

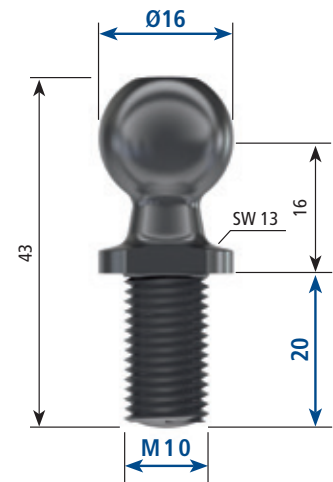

We reserve the right to make modifications. Dimensions in mm.
Änderungen vorbehalten. Maßangaben in mm.