

Mounting instruction

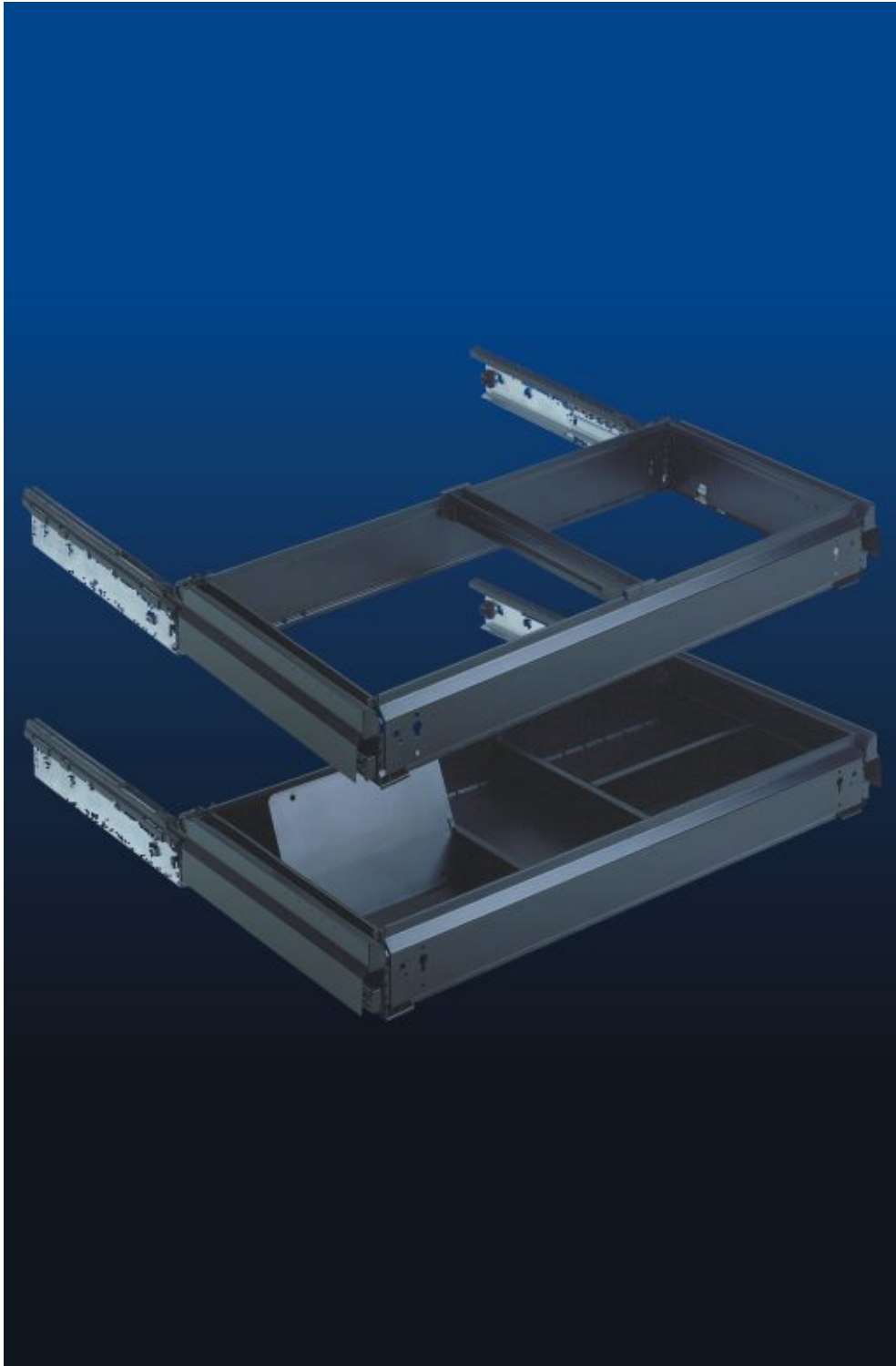

Pro-Line II filing frame

Mounting instruction for Pro-Line II filing frame

The cabinet brackets are screwed into the side walls before glueing. At the end of the production, the frame will be assembled without tools. Moreover, the modular platform system is serving the advantage of a high flexibility and a considerably low demand of storage space.



Pro-Line II filing frame assembly in 6 steps:



- (1) Screw-in the cabinet brackets**
in the flat lying side walls before glueing (bore holes see drawings)
- (2) Attach the slide assemblies**
front cutout of cabinet brackets for installation with front cover
rear cutout for installation behind doors (22 mm set-off)
- (3) Attach the front and rear panel**
put stronger deflected panel in front
- (4) Insert the connection rod**
- (5) Snap-in the pinion retainer clips**
push both clips towards the pinion wheels until they click into place
- (6) Attach the cross bars**
2 each retainers per cross bar

Disassembly:

- (1) Pull out the filing frame**
- (2) Detach the pinion retainer clips**
lift latch and pull the clip backwards
- (3) Remove the connection rod**
- (4) Remove the filing frame (see illustration)**
lock rear panel; lift frame at the frontside and pull forward,
until the bayonet lancings are released; then take off the frame



Mounting instruction for Pro-Line II wide drawer

With few manipulations, the Pro-Line II filing frame can be converted into a wide drawer, ideal for file storage. Accessories and examples for drawer partition or index-card formation are shown in the brochure "Pro-Line II filing frame".



Pro-Line II wide drawer assembly in 8 steps:

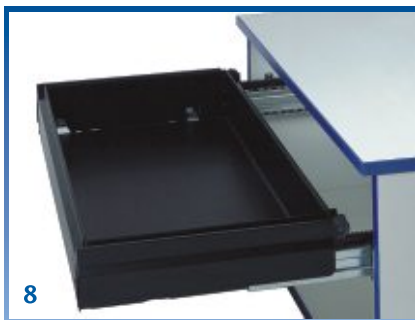

(1) - (5) like Pro-Line II filing frame

(6) Remove the edge profiles

from both front panel and rear panel.

(7) Install the drawer insert

Fix one border of drawer insert on front panel, then slightly overbend the drawer insert, finally fix other border of drawer insert on rear panel.

(8) Drawer organization as necessary

Accessories for drawer partition and index-card formation please find in the brochure "Pro-Line II filing frame".

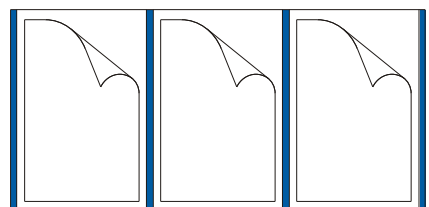

For detailed information about drawer partition and index-card formation please refer to the brochure "Pro-Line II filing frame".

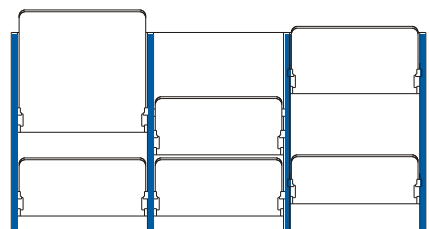

Mounting instruction for accessories

Installation with front cover:

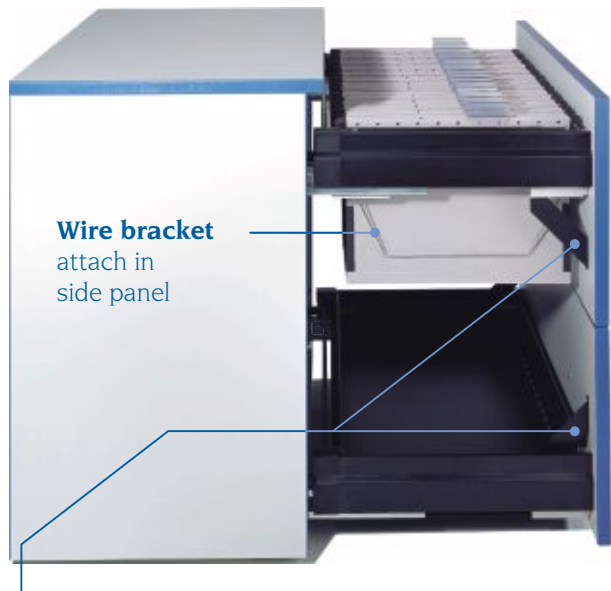

Front cover support

Filing frame: insert from below in zinc bracket
Wide drawer: screw from inside into side panel with self-tapping screw M3 x 6 mm - Article-No. 090.09846 (bore hole is concealed under the edge profile)

Installation behind doors:

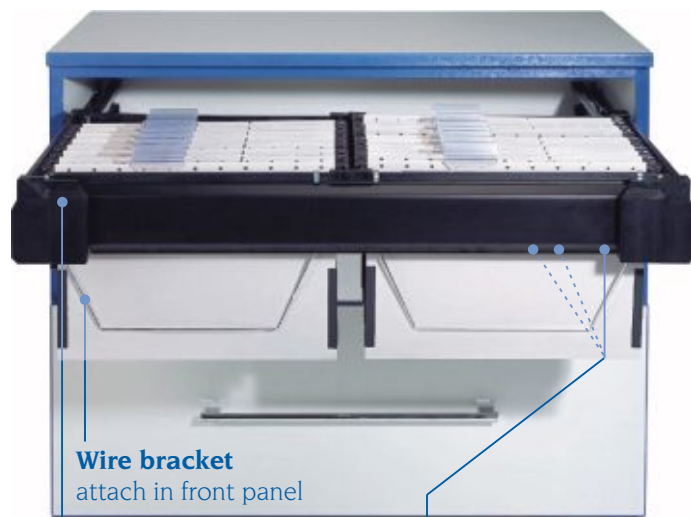

Cover cap

put on front panel and lateral shroud; pull front edge profile over both cover caps

Bore holes Ø 5 mm

to fasten custom-designed grips; distance 96+128 mm

Adaptation of locking systems:

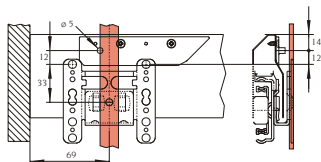

Huwil SVS 3

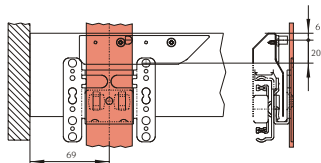

Lehmann Simultan Stop

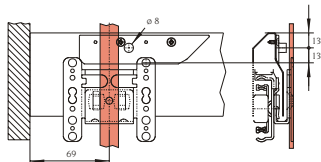

Ojmar Sistema 1038

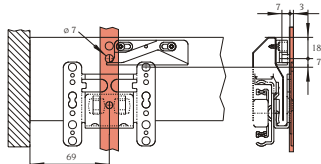

Standard locking device

Locking rod

routed between side wall and cabinet bracket

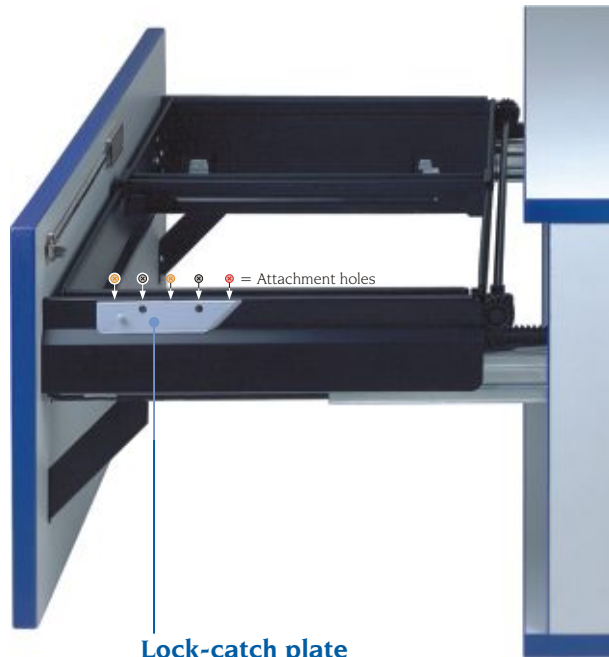

Lock-catch plate

screw-into mounting holes of the shrouds
Position ⊗ ⊗ for installation with front cover
Position ⊗ ⊗ for installation behind doors
Position ⊗ for special dimensions