

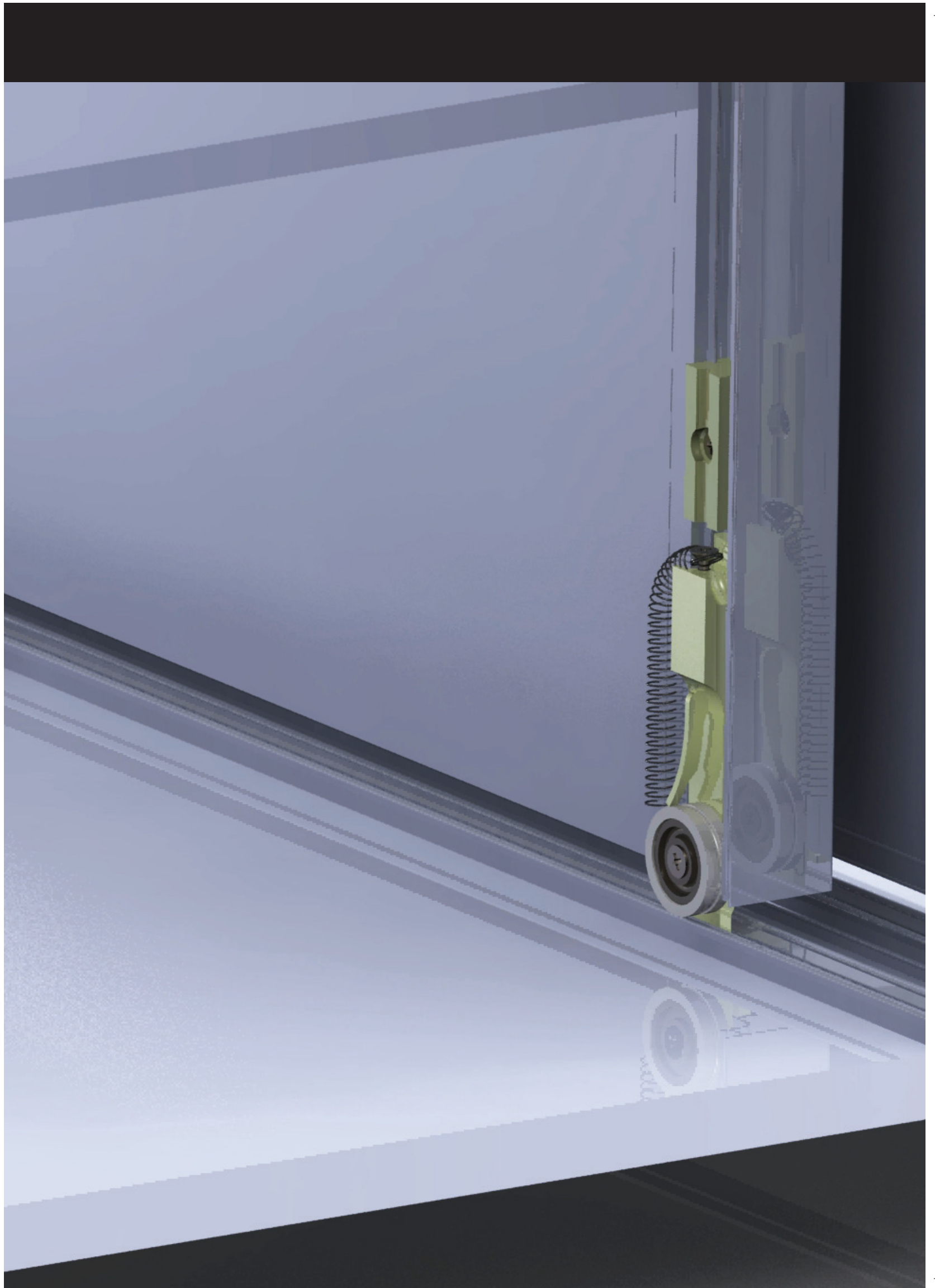

ITALIANO
Glidor **N**



PERCHE' GLIDOR-N



PER GRANDI NUMERI O FAI DA TE

GRAZIE all'elegante e brillante ingegnerizzazione



REALIZZAZIONE DELLE ANTE
ESTREMAMENTE EFFICIENTE

GRAZIE al loro assemblaggio in meno di 3 minuti



MOVIMENTO FLUIDO E SICURO

GRAZIE alla doppia clip anti scarrucolamento



POSSIBILITA' DI REALIZZARE ANTE
ESTREMAMENTE GRANDI FINO A 2,7 MT.
(H) X 2 MT.(L)

GRAZIE al profilo brevettato Hardoor per
montaggio nell'anta



DESIGN VERSATILE DELL'ANTA E
RIDUZIONE DEI PROFILI A STOCK

GRAZIE allo speciale design per legno e vetro



MONTAGGIO SEMPLICE E RAPIDO
DELL'ANTA

GRAZIE ai 12 mm di regolazione fine



AUTOCHIUSURA AMMORTIZZATA
SOFT CLOSING

GRAZIE al sistema di ammortizzamento
a doppio effetto

Glidor

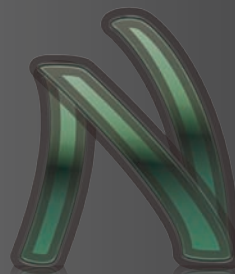

DESCRIZIONE SISTEMA

SUPERIORE

- BINARIO
- CARRELLO
- SOFT CLOSING

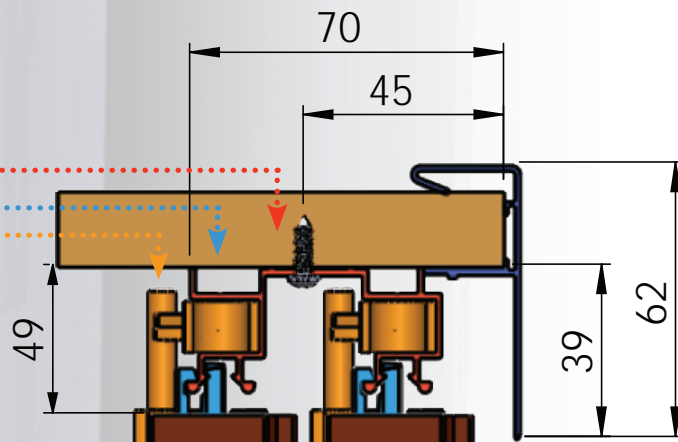

INFERIORE

- CARRELLO
- BINARIO

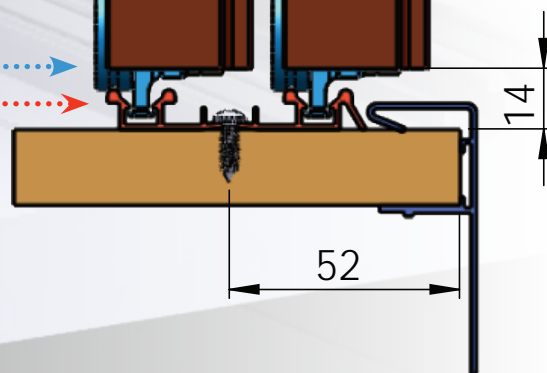

SOLUZIONI ANTA

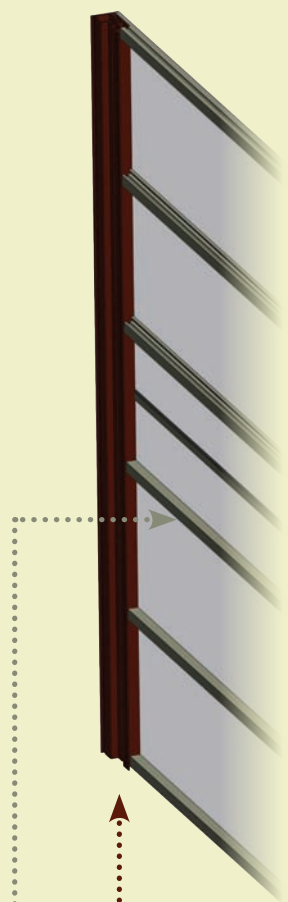

■ PROFILO ANTA
(PAG. 6)

■ SOLUZIONI PER IL
VETRO (PAG. 7)

COMPONENTI DEL SISTEMA

BINARIO

Binario largo,
ammortizzamento
nascosto

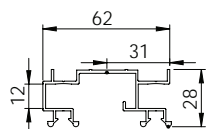

Art.	Anta
7589	Qualsiasi

BINARIO

Binario standard
largo

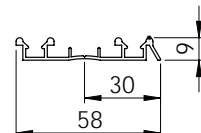

Art.	Anta
7083	Qualsiasi

BINARIO

Binario stretto,
ammortizzamento
nascosto

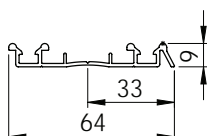

Art.	Anta
7590	Qualsiasi

BINARIO

Binario standard
stretto

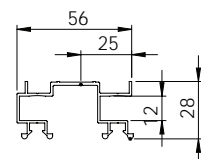

Art.	Anta
7084	Qualsiasi

BINARIO

Binario incassato

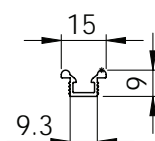

Art.	Anta
7584	Qualsiasi

CARRELLI

ART.	DESCRIZIONE
7022	Set Glidor N per anta

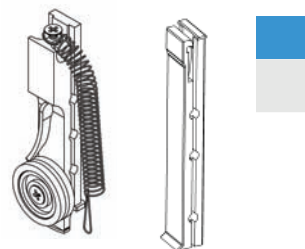

OPZIONI SOFT CLOSING

ART.	PART NAME
7899	Glidor N - Attivatore superiore
7900	Glidor N - Attivatore inferiore
7357	Soft Closing



Glidor
N

PROFILI ANTA

PROFILO ROTONDO 25 MM

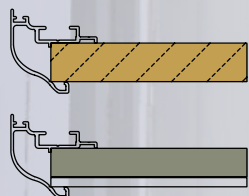

Art.	Anta	Vetro
7116	16mm	4mm
7927	18mm	4mm
7928	19mm	4mm

Per montaggio con :

■ Binario No. 7589,7083 ■ Attivatore No. 7899

PROFILO ROTONDO 40 MM

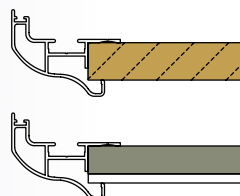

Art.	Anta	Vetro
7086	16mm	4mm
7117	18mm	4mm
7930	19mm	4mm

Per montaggio con :

■ Binario No. 7589,7083 ■ Attivatore No. 7900

PROFILO QUADRO 4 MM

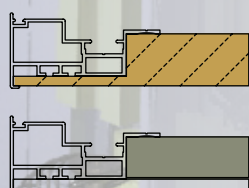

Art.	Anta	Vetro
7579	19mm	4mm
7104	21mm	4mm

Per montaggio con :

■ Binario No. 7590,7084 ■ Attivatore No. 7900

PROFILO ANGOLARE 4 MM

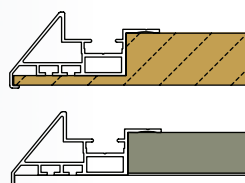

Art.	Anta	Vetro
7581	19mm	4mm
7110	21mm	4mm

Per montaggio con :

■ Binario No. 7590,7084 ■ Attivatore No. 7900

PROFILO ANGOLARE 9 MM

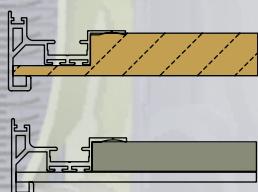

Art.	Anta	Vetro
7106	16mm	4mm
7923	18mm	4mm
7583	19mm	4mm

Per montaggio con :

■ Binario No. 7590,7084 ■ Attivatore No. 7900

PROFILO ANGOLARE 9 MM

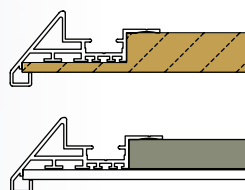

Art.	Anta	Vetro
7255	16mm	4mm
7926	18mm	4mm
7580	19mm	4mm

Per montaggio con :

■ Binario No. 7590,7084 ■ Attivatore No. 7900

PROFILO MANIGLIA 15 MM

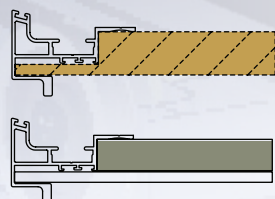

Art.	Anta	Vetro
7879	16mm	4mm
7931	18mm	4mm
7932	19mm	4mm

Per montaggio con :

■ Binario No. 7590,7084 ■ Attivatore No. 7900

PROFILO NASCOSTO PER ANTE SOTTILI

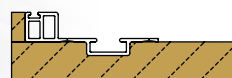

Art.	Anta
7437	Min. 12mm

Per montaggio con :

■ Binario No. 7590,7084 ■ Attivatore No. 7900

SOLUZIONI PER IL VETRO

PROFILO 12 MM PER SUPPORTO VETRO

Usato per sostenere la struttura ante nelle ante a vetri

Art.	Vetro
7065	4mm

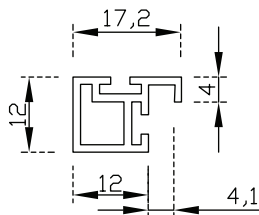

PROFILO 14 MM PER SUPPORTO VETRO

Usato per sostenere la struttura ante nelle ante a vetri

Art.	Vetro
7960	4mm

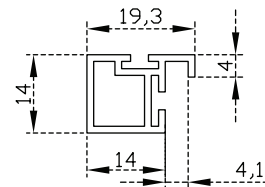

PROFILO 15 MM PER SUPPORTO VETRO

Usato per sostenere la struttura ante nelle ante a vetri

Art.	Vetro
7585	4mm

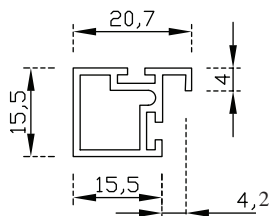

PROFILO 17 MM PER SUPPORTO VETRO

Usato per sostenere la struttura ante nelle ante a vetri

Art.	Vetro
7066	4mm

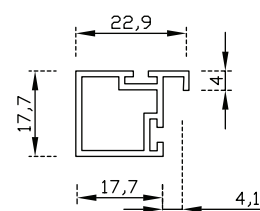

PROFILO DI SEPARAZIONE AD H 5 MM / 9 MM PROFILO FINALE AD U 5 MM / 9 MM

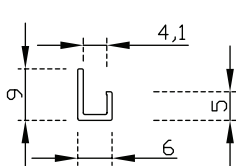

Art.	Vetro
7358	4mm

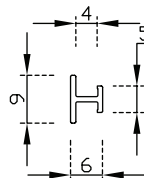

Art.	Vetro
7119	4mm

STRISCIA IN ALLUMINIO

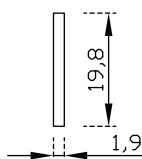

Art.
7435

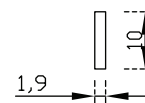

Art.
7434

PROFILI DI COPERTURA

PROFILO SEMPLICE DI COPERTURA

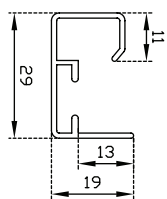

Art.	Anta
7133	17mm
7073	18mm

PROFILO DOPPIO DI COPERTURA

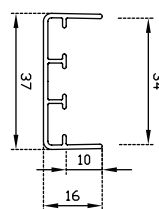

Art.	Anta
7490	17mm
7075	18mm

ZOCCOLO 62 MM

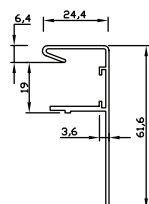

Art.	Anta
7120	17mm
7970	18mm

